

The New Generation of Communicating Controllers



ZigBee Metering Device ZMETER

User Manual

Revision: 3.00

Document: UM_ZMETER_20100317_001_03_00

S.A. au capital de 167 200 €
R.C.S. Saint Brieuc TGI 450 570 767
Siège social : 8 rue Bourseul 22300 Lannion France
Tél. : +33 (0) 2 96 48 68 18 – Fax : +33 (0) 2 96 48 19 11

WARRANTY

The device supplied to the buyer and/or the recipient is guaranteed by CLEODE against any malfunctions originating from a design and/or manufacturing flaw, for a period of twelve (12) months following delivery. The buyer and/or recipient is (are) responsible for proving the existence of the said defects or flaws. This warranty is applicable in accordance with articles 1641 to 1648 of the French Civil Code and in compliance with the French statutory warranty. The warranty covers the replacement free of charge of devices and parts affected by a design and/or manufacturing flaw excluding conspicuous defects in the device that are covered by the buyer and/or the recipient.

In order to invoke the warranty, the buyer must immediately send written notice to CLEODE of the flaws that it attributes to the device. It must enable CLEODE to have access to the device to observe these defects and repair them. The warranty provided by CLEODE is strictly limited to the equipment provided and shall only have for effect the replacement or repair, at CLEODE's expense, on its own premises, of all devices or parts that are not functioning as a result of defects or flaws. CLEODE reserves the right to modify the devices in order to comply with the warranty.

The warranty does not apply to replacement or repairs that may result from normal wear and tear of devices, systems or products, damage or accidents resulting from negligence, failure to supervise or maintain, or incorrect use of the devices, systems and/or products.

The maintenance service is provided by CLEODE with all reasonable care possible and in compliance with the current state of the arts.

The exchange of parts or repairs performed under the warranty cannot result in extending the length of the warranty. In no event can the unavailability of the device due to servicing give rise to compensation for any reason whatsoever. The seller is released from all obligations relating to the warranty if the product or device has been modified without prior written consent, or if original parts have been replaced by parts which it has not manufactured without prior consent. If unforeseen damage is caused by the device, it is expressly agreed that the seller can only be liable for the reimbursement of monies received for the purchase of the device if it has been destroyed. Under no circumstances can the seller be held liable for indirect or contingent damage. The seller is released from any liability and the buyer waives any rights against it if an accident or direct or indirect damage is caused to the buyer following a defect, incorrect usage, incorrect maintenance or normal wear of the device sold.

TABLE OF CONTENT

WARRANTY	2
REFERENCE DOCUMENTS	5
I INTRODUCTION	6
I.1 ZIGBEE METERING DEVICE PRESENTATION	6
I.2 COPYRIGHT	6
II METERING DEVICE DESCRIPTION	7
II.1 ZIGBEE PRESENTATION	7
II.2 ENERGY METER APPLICATION	7
II.2.1 METERING APPLICATION DESCRIPTION	7
II.2.2 CLUSTER DESCRIPTION	8
III INSTALLATION AND NETWORK ASSOCIATION	10
III.1 INSTALLATION	10
III.1.1 DOUBLE-SIDED TAPE INSTALLATION	10
III.1.2 SCREW INSTALLATION	10
III.1.3 CONNECTION TO THE ELECTRIC METER	11
III.1.4 CONNECTION TO THE WATER METER	12
III.1.5 CHANGE THE BATTERIES	13
III.2 STARTING UP ZMETER	14
III.3 RESTART OF THE ASSOCIATION PHASE	15
III.4 RESET	15
IV TECHNICAL FEATURES	16
REPAIR AND MAINTENANCE	17

TABLE OF REVISIONS

Version	Authors(s)	Version description	Date
0.1	CLEODE	Initial version	16/03/2010
1.0	CLEODE	Validated document	17/03/2010
1.1	CLEODE	Updated to new design	16/09/2011
2.0	CLEODE	Validated document	20/09/2011
2.1	CLEODE	Removal of the connector jack female	26/03/2015
3.0	CLEODE	Validated document	26/03/2015

REFERENCE DOCUMENTS

N°	Document	Description
[1]	ZigBee_Cluster_Library_Public	Zigbee Cluster Library specification
[2]	ZigBee_Smart_Energy_Profile	Smart Energy profile specification
[3]	ZigBee_Specification	ZigBee specification

I INTRODUCTION

I.1 ZIGBEE METERING DEVICE PRESENTATION

The meter of consumption ZigBee™ (ZMETER) allows measuring the consumption of water or electricity of a home from the electricity meters or water.

For that purpose, the ZMETER must be connected to a probe. This probe differs according to the type of meter (water or electricity):

- For the electric meters, the probe uses the bright flash of meter as meter SAGEM C1000.
- For water meters, a sensor with effect hall must be connected with the ZMETER as the sensor SAPPEL PULSAR v3.5

The ZMETER has this form:



The ZMETER module Zigbee™ works in conjunction with a Zigbee coordinator™ compatible stack pro 2007.

CLEODE also markets Coordinators Zigbee™.

Contact : support@cleode.com ou Web : www.cleode.fr for more information

I.2 COPYRIGHT

The CLEODE trademark and the CLEODE logo are properties of CLEODE SA, France. This document also refers to trademarks and other product names that are registered trademarks of their respective owners.

Copyright © 2009 CLEODE SA. All rights reserved.

II METERING DEVICE DESCRIPTION

II.1 ZIGBEE PRESENTATION

The meter of consumption ZigBee™ contains an application of counting of energy of type Metering Device defined in the standard Smart Energy (Cf. document [2]).

This object ZigBee™ is in accordance with the standard ZigBee pro 2007 and with the Home Automation profile. For more detail of the exchanged data, please refer to documents [1, 2 and 3].

II.2 ENERGY METER APPLICATION

The measure of consumption is made through a report on a value on the cluster Metering Device.

II.2.1 METERING APPLICATION DESCRIPTION

- Device ID : Metering Device
- Endpoint number: 1
- Clusters :

Server	Client
Basic (0x0000)	/
Identify (0x0003)	/
Alarms (0x0009)	/
Power Configuration (0x0001)	/
Simple Metering (0x0702)	/

II.2.2 CLUSTER DESCRIPTION

This is a terse description of clusters and attributes which are implemented in the ZMETER. For more detail on these, see document [1].

- Basic cluster :

This cluster is used to determine basic information about the device.

Attribute	Attribute ID
ZCLVersion	0x0000
ApplicationVersion	0x0001
StackVersion	0x0002
HWVersion	0x0003
ManufacturerName	0x0004
ModelIdentifier	0x0005
DateCode	0x0006
PowerSource	0x0007
LocationDescription	0x0010
PhysicalEnvironment	0x0011
DeviceEnabled	0x0012
AlarmMask	0x0013

- Cluster Power Configuration :

This cluster is used to specify the min threshold of battery level by setting the *BatteryVoltageMinThreshold* attribute value.

Attribute	Attribute ID
BatteryAlarmMask	0x0035
BatteryVoltageMinThreshold	0x0036

- Identify cluster :

This cluster is used to put a device into an identification mode. By writing the *IdentifyTime* attribute value, the user ask the device to blink the light, during a number of seconds specified by this value.

Attribute	Attribute ID
IdentifyTime	0x0000

- Alarms cluster:

This cluster is used to signal an alarm. In the case of ZMETER, only the low battery power level is processed. If the battery power level is too low (under 2,4V) the *AlarmCount* value changes to 1 and a command message is send to coordinator.

Attribute	Attribute ID
AlarmCount	0x0000

- Simple Metering cluster:

The ZMETER implements these attributes:

Attribut	Identifiant de l'attribut
CurrentSummationDelivered	0x0000
Status	0x0200
UnitofMeasure	0x0300
Multiplier	0x0301
Divisor	0x0302
SummationFormatting	0x0303
DemandFormatting	0x0304
MeteringDeviceType	0x0306
InstantaneousDemand	0x0400

The type of transmitted value (energy or water) is indicate by *UnitofMeasure* attribute (0x00 : Kw and Kwh, 0x01 : m³ and m³/h).

The type of metering device is indicate by *MeteringDeviceType* attribute (0 : electricity, 2 : water)

Among the attributes of the cluster Simple Metering, two can send their value in a periodic way. It is about clusters:

- CurrentSummationDelivered: it represents the quantity of energy consumed since the stake in functioning of the ZMETER, in kWh for the electric meters, m3 for water meters.
- InstantaneousDemand: immediate power in KW for the electric meters, in m3 / hour for water meters.

They use for it the mechanisms of report described in the document [1].

Every 12 hours, the value of CurrentSummationDelivered is saved in memory not fowls, it allows in case of power cut to keep this value.

III INSTALLATION AND NETWORK ASSOCIATION

III.1 INSTALLATION

III.1.1 DOUBLE-SIDED TAPE INSTALLATION

To mount the ZMETER with a double-sided tape, follow this:

- 1) Stick a double-sided tape on the ZMETER bottom
- 2) Dust the wall
- 3) Mount the ZMETER on the wall

III.1.2 SCREW INSTALLATION

To fix the ZMETER by means of the system of screw, follow the following procedure.

1. To position the ZMETER in the wished place, you may mark the position of both fixing holes by using the size below.

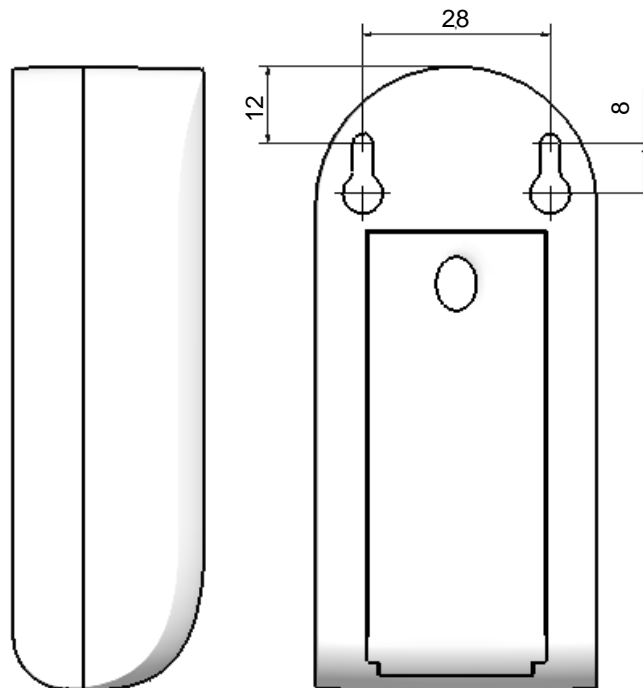

2. Drill the wall by taking into account your system of fixation (ankles + screw).
3. Screw the screws so as to leave approximately 3 mm enter the head of screw and the wall.
4. Position the case to make correspond both fixing holes and screws them.

5. Stick the ZMETER to the wall; make a side movement downward to finalize the installation as indicate on the picture below.

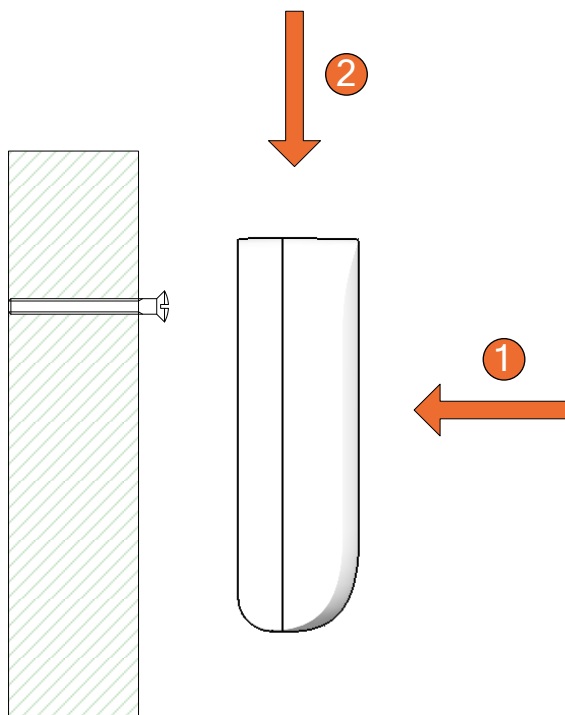

III.1.3 CONNECTION TO THE ELECTRIC METER

To connect the meter of consumption to the electric meter, follow the following procedure.

Locate the position of the bright flash on the electric meter and clean the tour to stick the sensor.

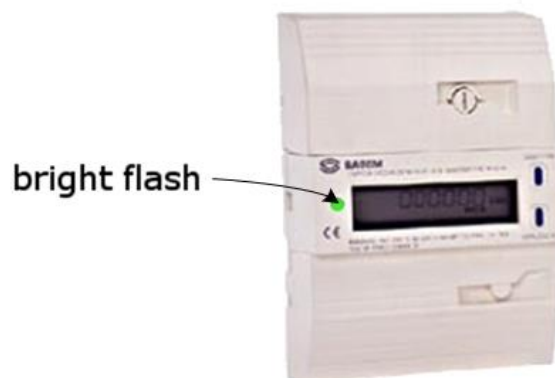

Remove the protection of the adhesive of the sensor supplied with the meter of consumption.



Stick the sensor on the light of the electric meter so that center of the sensor is in front of the light of the meter.



When the product ZMeter is with a connector jack female, connect the connector jack male 3,5 mm of the sensor to the connector jack female of the meter of consumption.

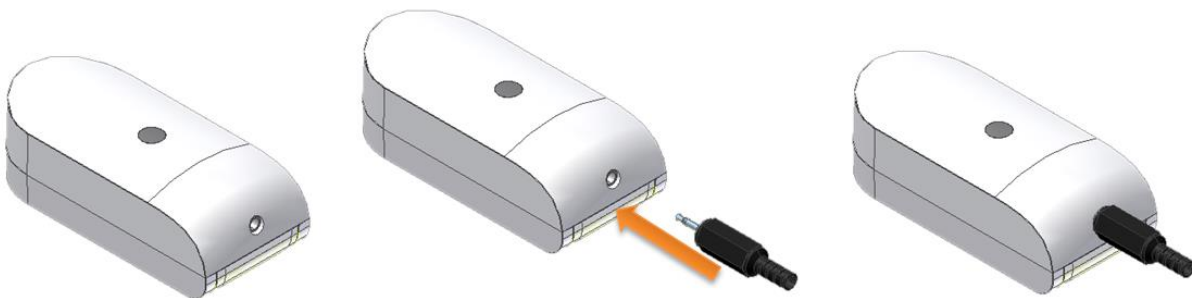

III.1.4 CONNECTION TO THE WATER METER

To connect the meter of consumption to the water meter, follow the following procedure.

Place the sensor with effect hall on your water meter as described in the procedure of the sensor.

When the product ZMeter is with a connector jack female, connect the connector jack male 3,5 mm of the sensor to the connector male jack of the meter of consumption.

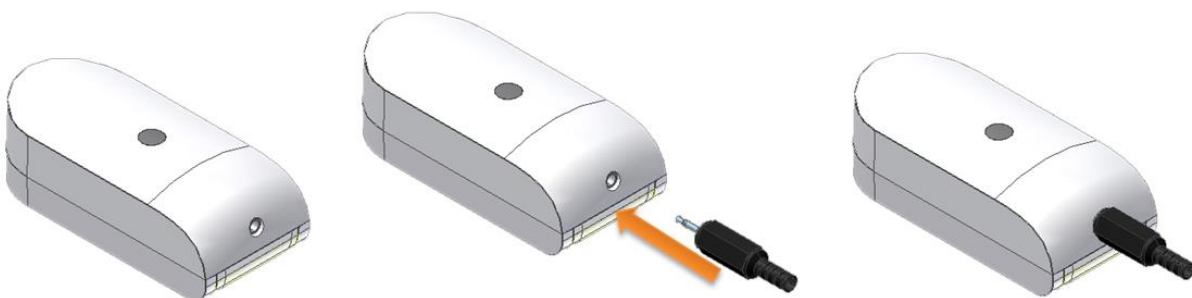

III.1.5 CHANGE THE BATTERIES

To change the batteries of the ZMETER, follow the following procedure.

Take down the ZMETER of the wall. For it, make a side movement upward then take away the ZMETER of the wall as indicate on the plan below.

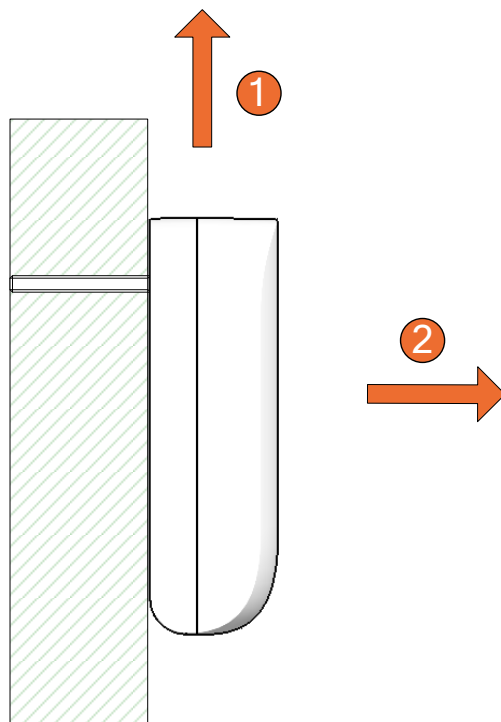

Turn the case and press on the end of the lid as indicated this against.

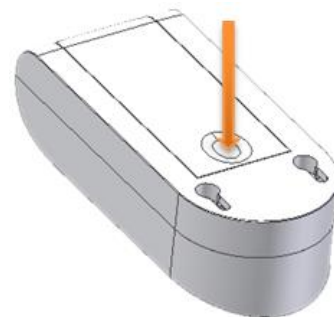

By continuing to press, pull on the lid to make slide downward of ZMETER.



Change batteries by respecting well the indicated polarity.



Put back the lid on the ZMETER by making it slide until it is to clip.



Once the ZMETER closed, you can put back it in position.

III.2 STARTING UP ZMETER

In the switched on of the object, it tries to join during about seconds and flashes twice.

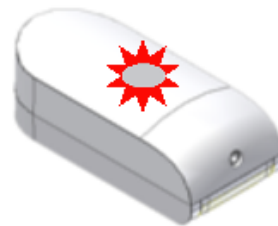

If a coordinator is present and what it authorizes the ZMETER to join the network, the light of the ZMETER flashing during 2 seconds then turn off.

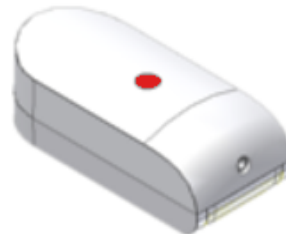

In the cases where the association is not possible, the object is going to put itself in sleep and to try automatically to join at the end of 15 minutes. This time will increase twofold in every new failure of the association.

III.3 RESTART OF THE ASSOCIATION PHASE

If the ZMETER is not associated, the user can ask him at any time to join a network.

For this, the user has to press during 3 seconds on the button.

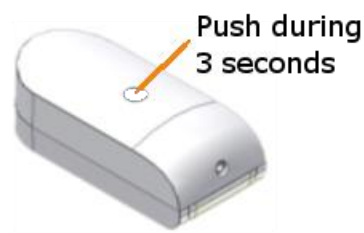

If the ZMETER was not associated it begins flashing quickly during 20 seconds. The ZMETER looks for a coordinator during this blinking.

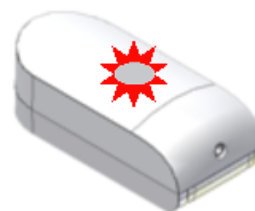

If the association is success, the light of the ZMETER flashing during 2 seconds and turn off.



If the light of the ZMETER does not flash after pressing on the button during 3 seconds, this means that he is already associated in a network.

III.4 RESET

If need, the user can reset the ZMETER.

For this, he has to press on the button during 5 seconds.

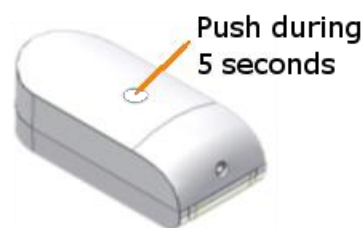

When the ZMETER reset, the LED flashes twice and turn off.

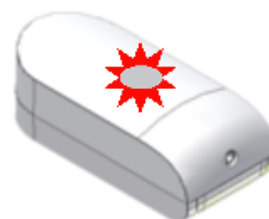

IV TECHNICAL FEATURES

Weight	50 g (without battery and without sensor)
Power Supply	2 x AAA batteries
Battery Life	> 1 year
Range detection	10 m
Transmission range	100 m outdoor 30 m indoor
Managed channels (frequency)	16 ZigBee™ channels (2.405 to 2.480 GHz)

REPAIR AND MAINTENANCE

Defective equipments shall be first reported to the CLEODE support team in order to be assigned an RMA number. Be prepared to state your name, company and the serial number of the defective item to the support personnel.

The item shall then be returned to CLEODE with the following documents:

- The RMA number
- A copy of the delivery slip
- A detailed description of the default and the test context

The maintenance period is typically four (4) weeks starting from the date of reception of the equipment at the CLEODE headquarters.

Remark : A FAQ (Frequently Asked Questions) is available on the www.cleode.com web site.



CLEODE S.A.
Technical Support Division

8, rue Bourseul
22300 Lannion
France

Phone : +33 (0) 2 96 48 68 18

Fax : +33 (0) 2 96 48 19 11

E-mail : support@cleode.com

Web : <http://www.cleode.com>